

with plastic pipe saddle Type RUK and U-profile (to be used as fixed point clamps only!)

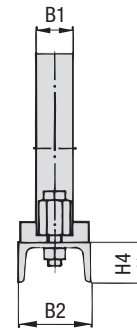

RUK

DN 40 dimension L4 is 90° staggered

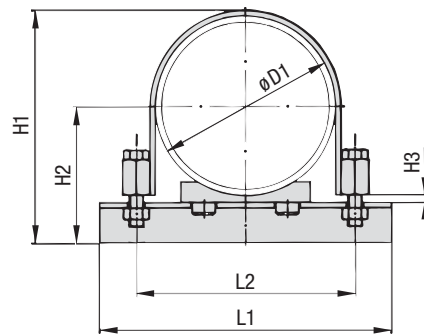
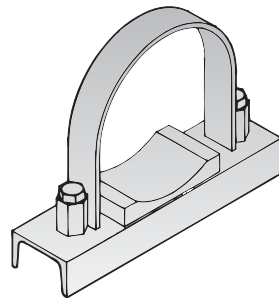
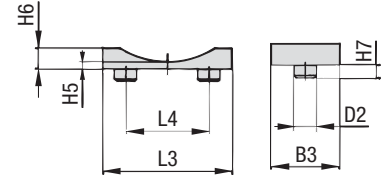

DN	Pipe-O.D. Ø D1		Round Steel U-Bolt FB							Flat Steel B1	U-profile B2 x H4	Plastic Pipe Saddle RUK							Accessories Hex Bolts								
	mm	inch	L1 mm	L1 inch	L2 mm	L2 inch	H1 mm	H1 inch	H2 mm			H2 inch	H3 mm	H3 inch	L3 mm	L3 inch	L4 mm	L4 inch		B3 mm	B3 inch	D2 mm	D2 inch	H5 mm	H5 inch	H6 mm	H6 inch
40	48,3	1 1/2	100	3.94	76	2.99	95	3.74	67	2.64	5		24	0.94	25		35	1.38	8	0.31	5		8	0.31	5	0.20	M10 x 40 3/8 - 16UNC x 1-5/8
	57		115		85	3.35	103	4.06	71,5	2.81			38				50		10				10		6		
50	60,3	2		4.53	88	3.46	106	4.17	73,2	2.88																	M12 x 55 7/16 - 14UNC x 2-1/8
	76,1	2 1/2	132	5.20	104	4.09	122	4.80	81	3.19	0.20	0.78 x 0.12															
65	88,9	3	160	6.30	122	4.80	146	5.75	97,5	3.84	8		75		40		70		15		8		17		10		M16 x 75 5/8 - 11UNC x 3
	108		170	6.69	140	5.51	165	6.50	107	4.21																	
80	114,3	4	180	7.09	147	5.79	171	6.73	110	4.33																	M20 x 80 3/4 - 10UNC x 3-1/8
	133		210		165	6.50	190	7.48	119,5	4.70																	
100	139,7	5		8.27	172	6.77	197	7.76	123	4.84																	M24 x 100 7/8 - 9UNC x 4
	159		265	10.43	201	7.91	220	8.66	132,5	5.22																	
125	168,3	6	275	10.83	211	8.31	230	9.06	137	5.39																	M24 x 100 7/8 - 9UNC x 4
	193,7		305	12.01	236	9.29	255	10.04	150	5.91																	
150	216	8	320	12.60	261	10.28	280	11.02	162,5	6.40																	M24 x 100 7/8 - 9UNC x 4
	219,1																										
175	267	10	380	14.96	325	12.80	328	12.91	186,5	7.34																	M24 x 100 7/8 - 9UNC x 4
	273		385	15.16	330	12.99	334	13.15	189,5	7.46																	
200	318	12	440	17.32	375	14.76	384	15.12	212	8.35																	M24 x 100 7/8 - 9UNC x 4
	323,9		450	17.72	382	15.04	390	15.35	215	8.46	0.31	1.57 x 0.31															
250	355,6	14	480	18.90	420	16.54	421	16.57	236	9.29																	M24 x 100 7/8 - 9UNC x 4
	368		490	19.29	430	16.93	434	17.09	242	9.53																	
300	406,4	16	550	21.65	470	18.50	472	18.58	261	10.27																	M24 x 100 7/8 - 9UNC x 4
	419				482	18.98	485	19.09	267,5	10.53																	
350	457	18	585	23.03	520	20.47	523	20.59	286,5	11.28																	M24 x 100 7/8 - 9UNC x 4
	508	20	630	24.80	570	22.44	574	22.60	312	12.28																	
500	521		640	25.20	585	23.03	587	23.11	319	12.56	0.47	2.36 x 0.31															M24 x 100 7/8 - 9UNC x 4

ORDER CODES

FB + RUK complete
FB + RUK/xx *,***

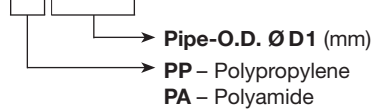

Clamp consisting of: (for FB + RUK only)

- 1 x Flat steel U-bolt clamp
- 1 x RUK/xx
- 1 x U-profile c/w nuts
- 2 x Hexagon head bolts DIN EN ISO 4014/4017

Round Steel U-Bolt
FB ** A * kompl**

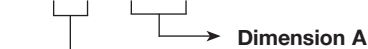

Material and surface finishing

- carbon steel St37, untreated
- carbon steel St37, zinc plated (Fe/Zn 8c)
- stainless steel A4 - 1.4401/1.4571 (AISI 316/316Ti)
- carbon steel St37, plastic coated

Plastic Pipe Saddle
RUK *,* xx**

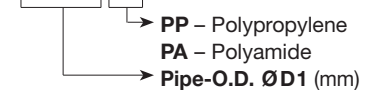

Information

Items are supplied non-assembled. Other materials and surface finishings upon request.

* Consult Factory for Availability